

03 Jamb Detail
1 : 5

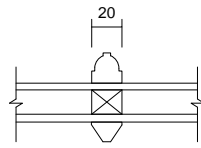

04 Glazing Bar Detail
1 : 5

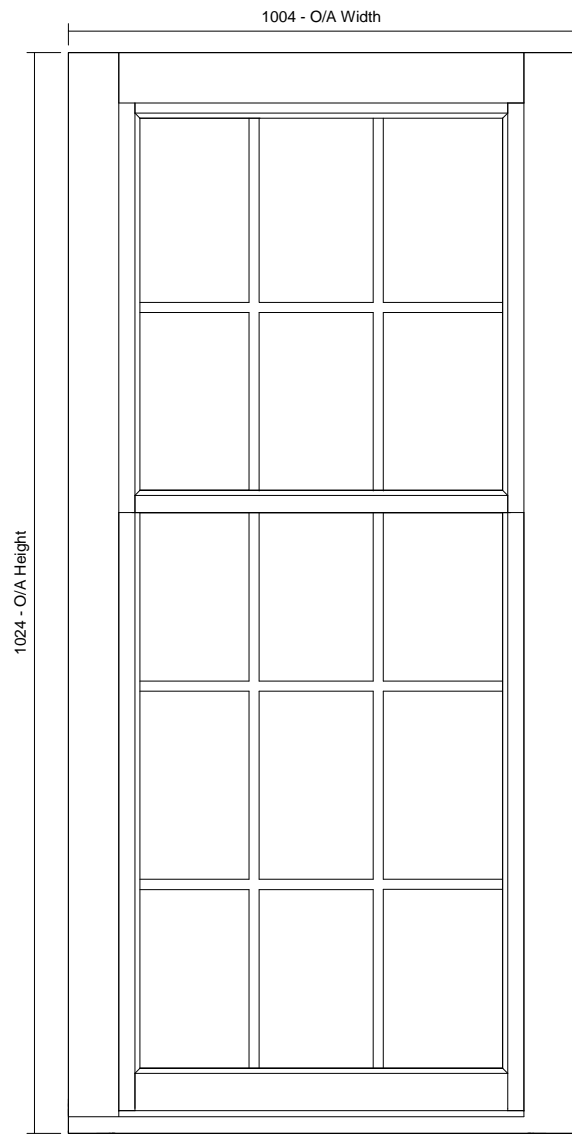

02 Front View
1 : 15

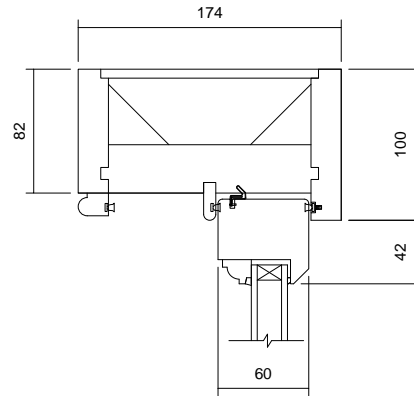

05 Head Detail
1 : 5

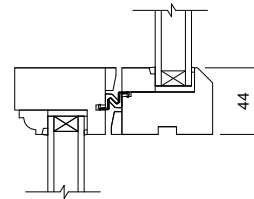

06 Meeting Rail Detail
1 : 5

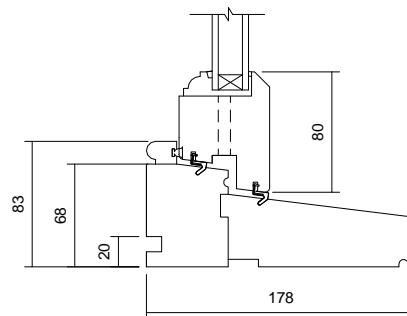

07 Cill Detail
1 : 5

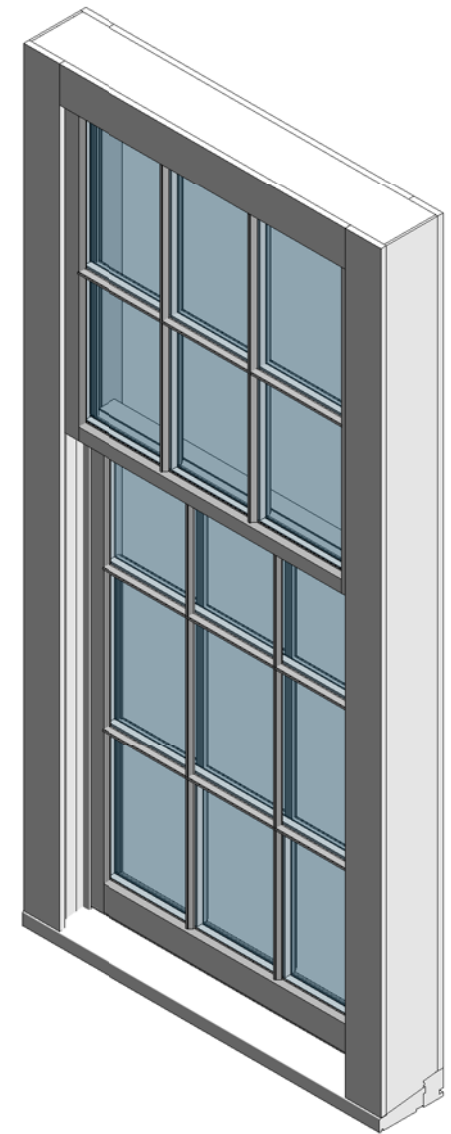

01 3D View

Window Schedule	
Height	Width
2144	1004

NOTE! ELEVATION DRAWINGS VIEWED EXTERNALLY

 <p>Made-to-order timber windows and doors</p>	Drawing Number B1/69		Drawn By DH
	Scale 1:5 & 1:15 @ A4	Revision	Date 26/09/16
	Customer		
	Project Box Sash 2144 x 1004		
T 01277 353857 www.lomaxwood.co.uk		© COPYRIGHT 2016 LOMAX-WOOD. ALL RIGHTS RESERVED	